



BA 7

AC INDUSTRIAL AXIAL FANS 7 Blades

Directly coupled motor. 7 blades with Concave blade system. Suitable for mounting on wall and window.

Technical Drawing

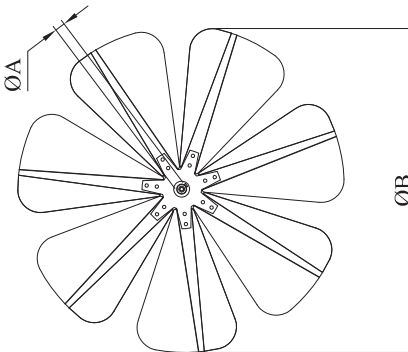
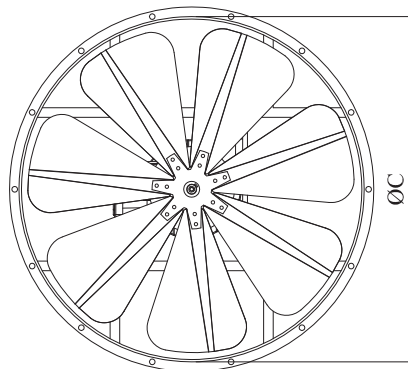
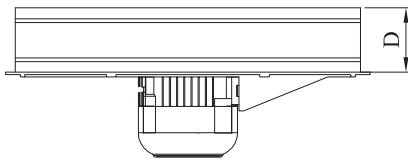

- MATERIAL** : Housing is made of electrostatic powder coated sheet metal, impeller is made of sheet metal with concave blade system.
- INSULATION CLASS** : Class B and Class F
- DIRECTIVE** : EN 60335-1, EN 60335-2-80
- SPEED CONTROL** : Speed can be adjusted using an optional controller.
- APPLICATION AREAS** : Factories, depots, dyehouses, shopping centers, workshops(plants) etc. Places where big volume air needed to ventilated.

TYPE	A	B	C	D
BA 7M - 7T 300	14	300	330	100
BA 7M - 7T 350	14	350	380	120
BA 7M - 7T 400	14	400	430	120
BA 7M - 7T 450	14	450	480	130
BA 7M - 7T 500	14	500	530	140
BA 7M - 7T 550	19	550	580	150
BA 7M - 7T 600	19	600	630	150
BA 7M - 7T 650	24	650	680	150
BA 7M - 7T 700	24	700	730	170
BA 7M - 7T 750	28	750	780	170
BA 7M - 7T 800	28	800	830	220

Dimensions are in (mm)

Accessories



BASP

BSC-F

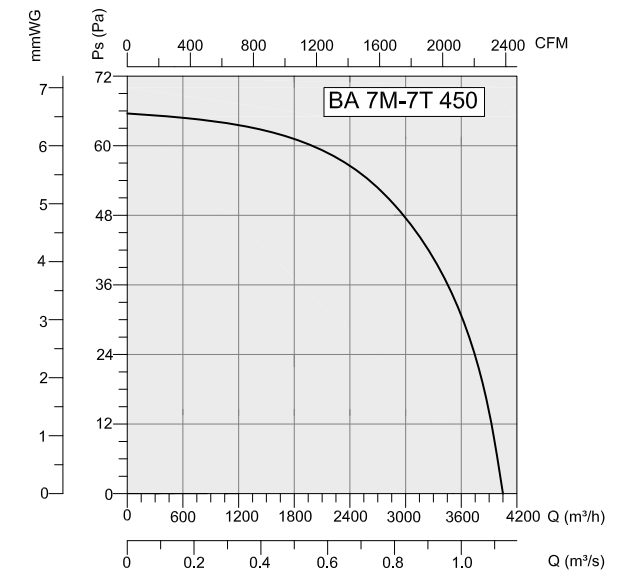
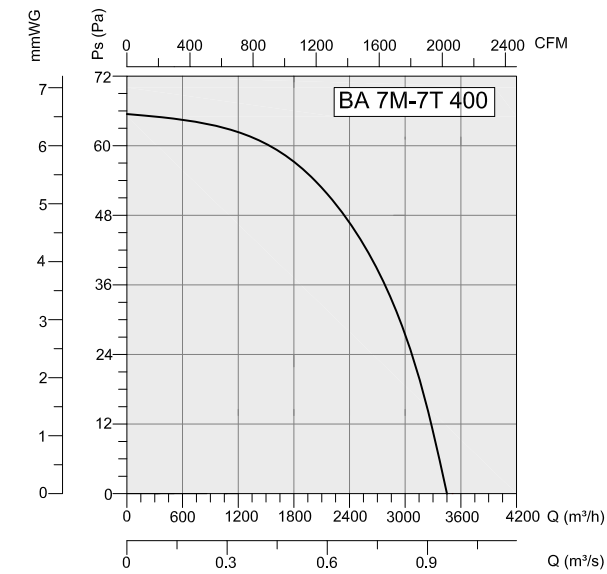
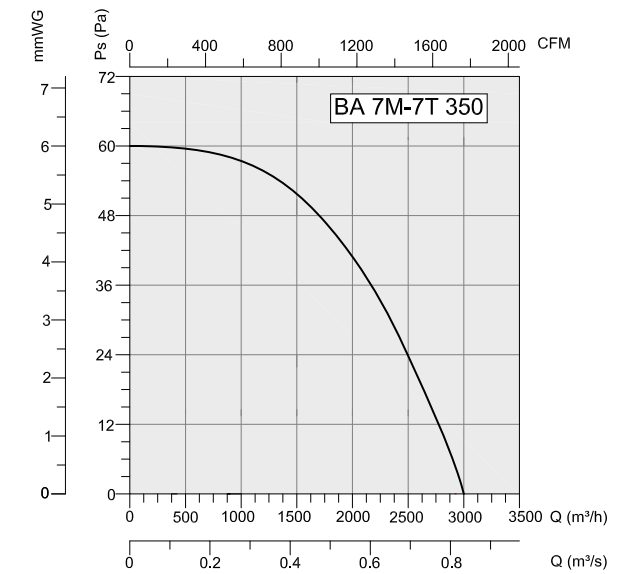
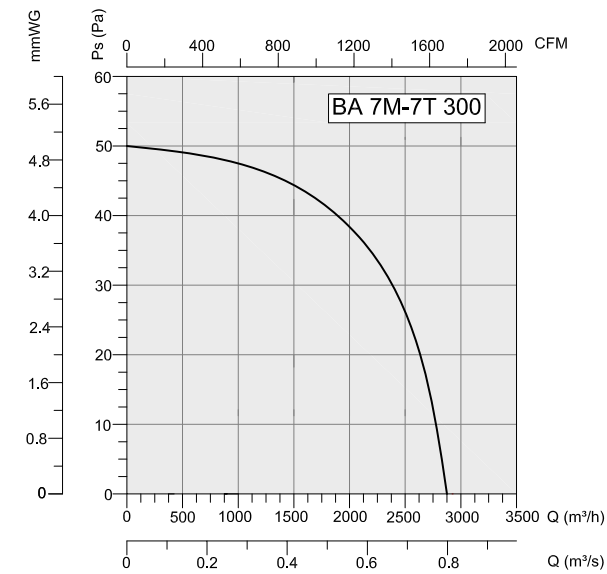

TYPE	VOLTAGE	FREQUENCY	POWER	CAPACITOR	SPEED	AIR FLOW	SOUND PRESSURE LEVEL	WEIGHT
	V	Hz	Kw	(µF)	rpm	m³/h	dB(A)	kg
BA 7M - 7T 300	230/380	50	0.25	-	1400	2750	-	-
BA 7M - 7T 350	230/380	50	0.25	-	1400	3000	-	-
BA 7M - 7T 400	230/380	50	0.25	-	1400	3500	-	-
BA 7M - 7T 450	230/380	50	0.25	-	1400	4000	-	-
BA 7M - 7T 500	230/380	50	0.37	-	1400	6000	-	-
BA 7M - 7T 550	230/380	50	0.55	-	1400	7875	-	-
BA 7M - 7T 600	230/380	50	0.55	-	1400	9500	-	-
BA 7M - 7T 650	230/380	50	1.1	-	1400	11000	-	-
BA 7M - 7T 700	230/380	50	1.5	-	1400	12000	-	-
BA 7M - 7T 750	230/380	50	2.2	-	1400	14000	-	-
BA 7M - 7T 800	230/380	50	3	-	1400	18000	-	-

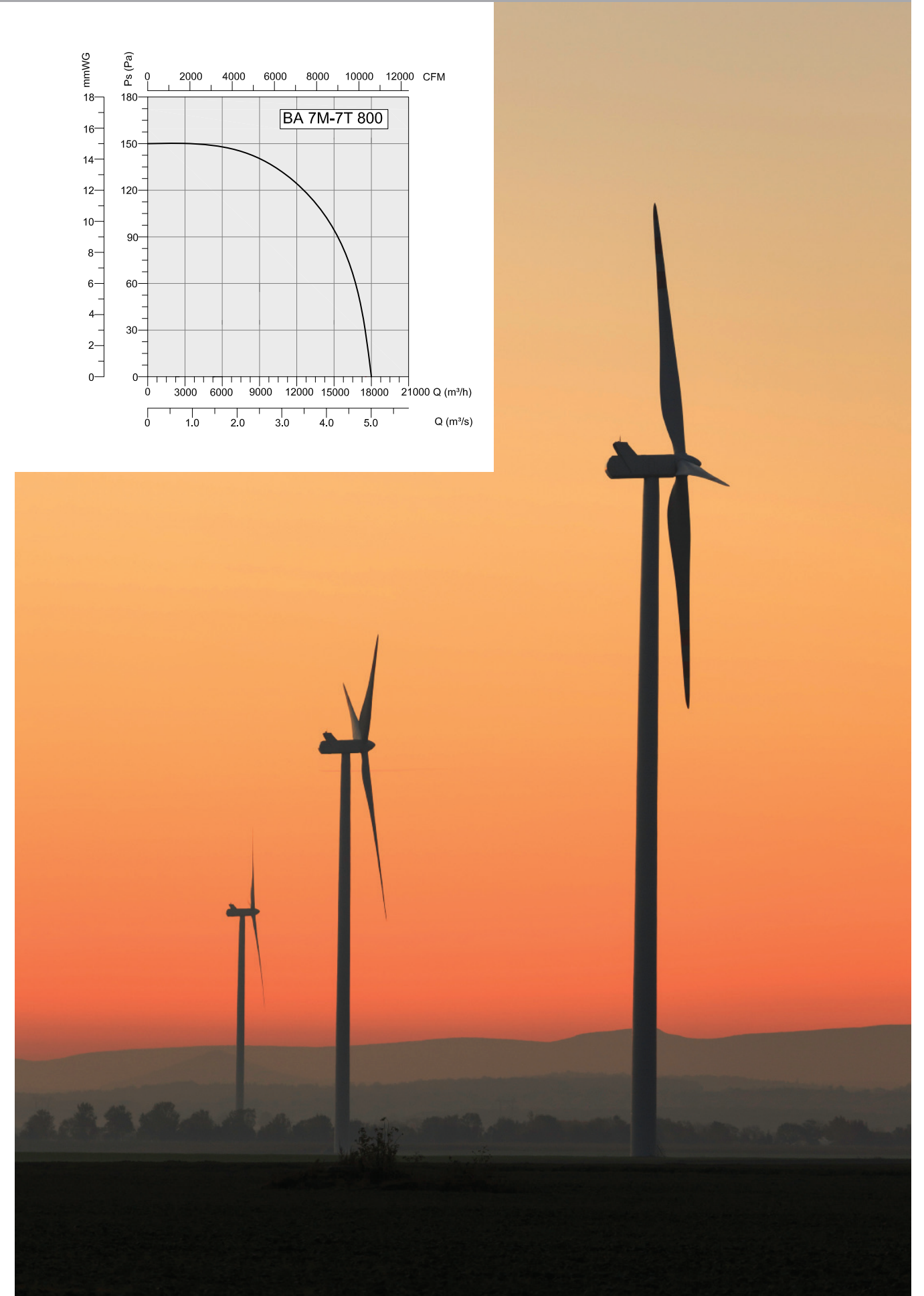
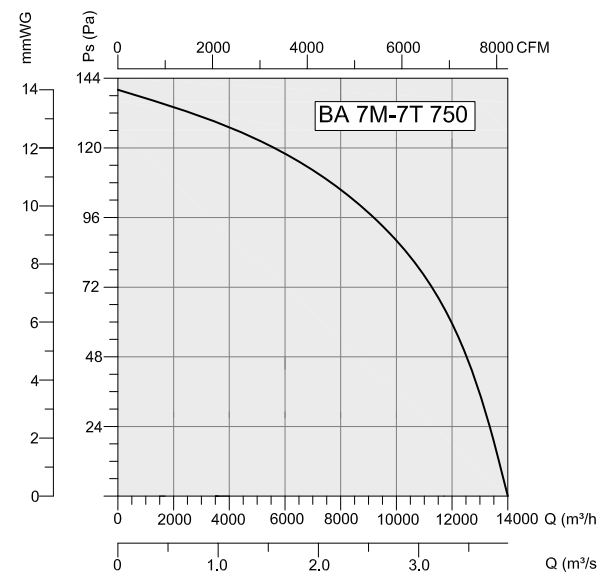
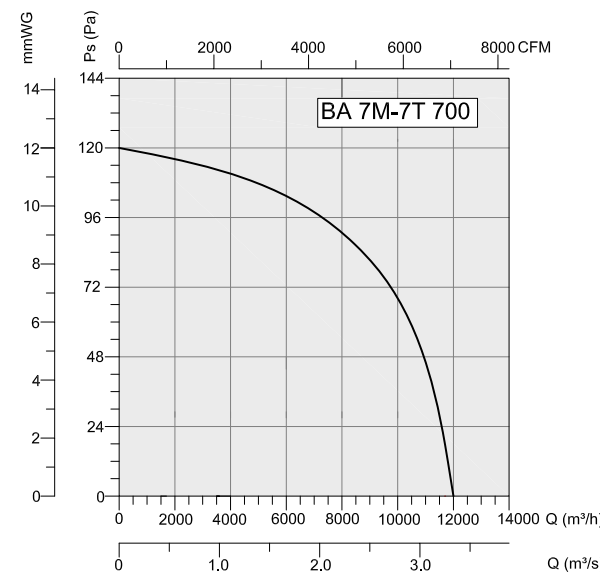
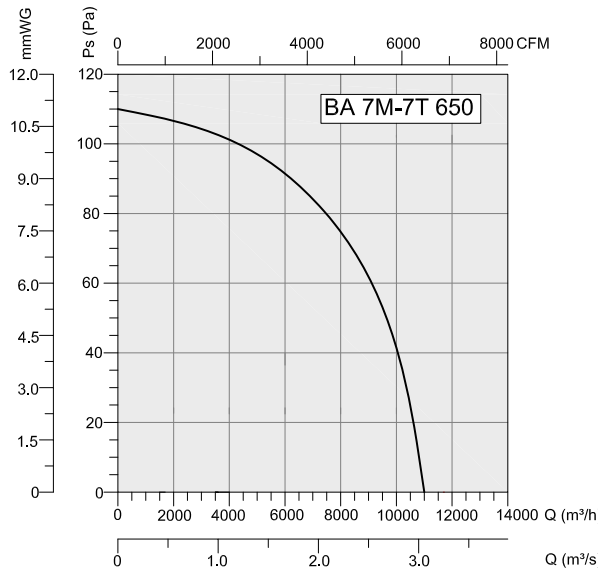
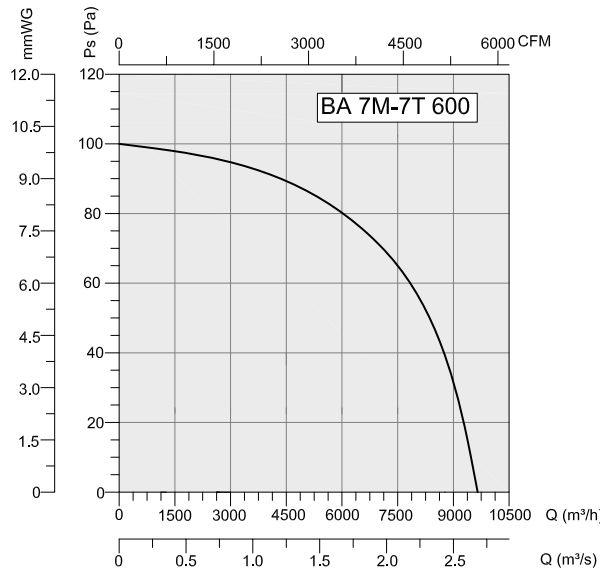
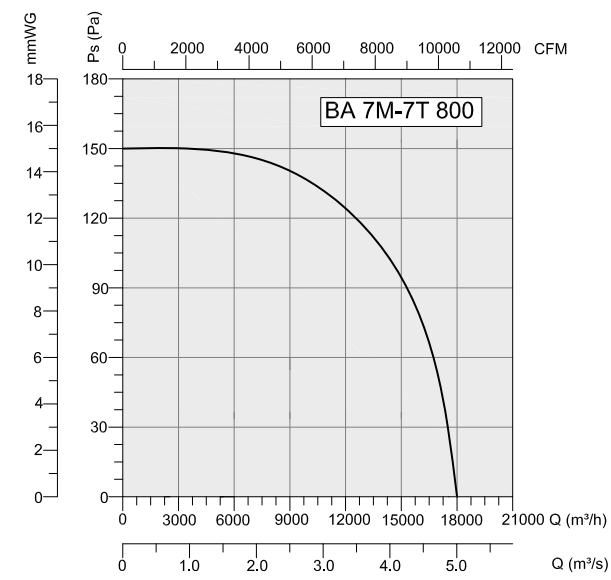
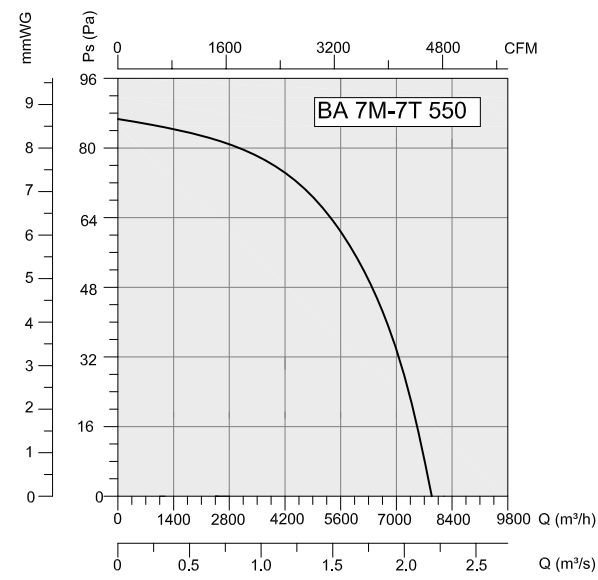
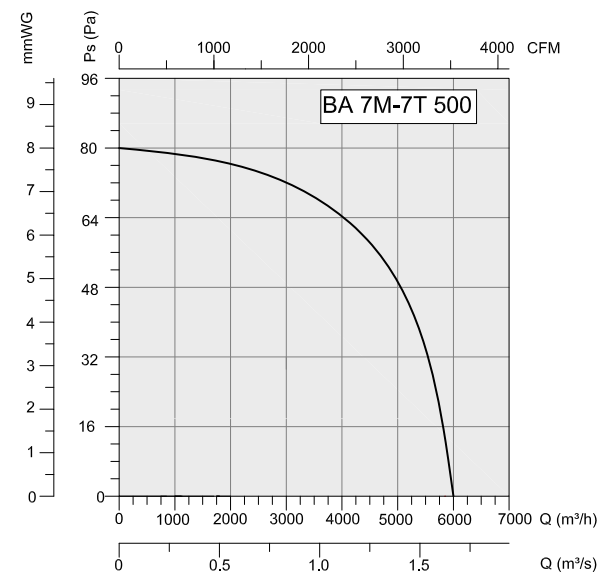

DUCT FANS

ROOF FANS

AXIAL FANS

RADIAL FANS

JET FANS

PLASTIC FANS

VENTILATORS

ACCESSORIES