



# BSKF-R

AC DIRECT DRIVE RECTANGULAR IN LINE DUCT FANS  
Forward Curved

Smoke Exhaust Fan (-40.....+120C)  
Smoke Exhaust Fan F400 c 2h  
Exproof Exhaust Fan (explosion proof fan)

## Technical Drawing

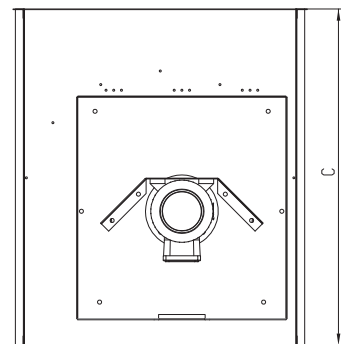
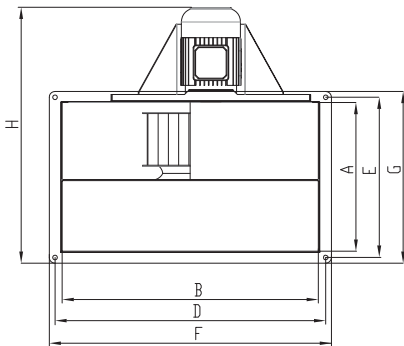

- MATERIAL** : Housing with backward inclined impeller is made of galvanized sheet metal.
- INSULATION CLASS** : Class F
- DIRECTIVE** : EN 60335-1, EN 60335-2-80  
F400C 2h EN 12101-3  
ATEX EN 13463-1
- SPEED CONTROL** : Speed can be adjusted using an optional controller.
- APPLICATION AREAS** : Kitchen exhaust, hotels, autoparks, buildings, shopping centers etc.

TYPE	A	B	C	D	E	F	G	H
BSKF-R 200	200	400	500	420	220	450	250	469
BSKF-R 225	250	500	560	520	270	550	300	519
BSKF-R 250	300	500	560	520	320	550	350	589
BSKF-R 280	300	600	710	620	320	650	350	589
BSKF-R 315	350	600	710	620	370	650	400	684
BSKF-R 355	400	700	780	720	420	750	450	766
BSKF-R 400	500	800	880	820	520	850	550	866
BSKF-R 450	500	1000	980	1020	520	1050	550	886

Dimensions are in (mm)

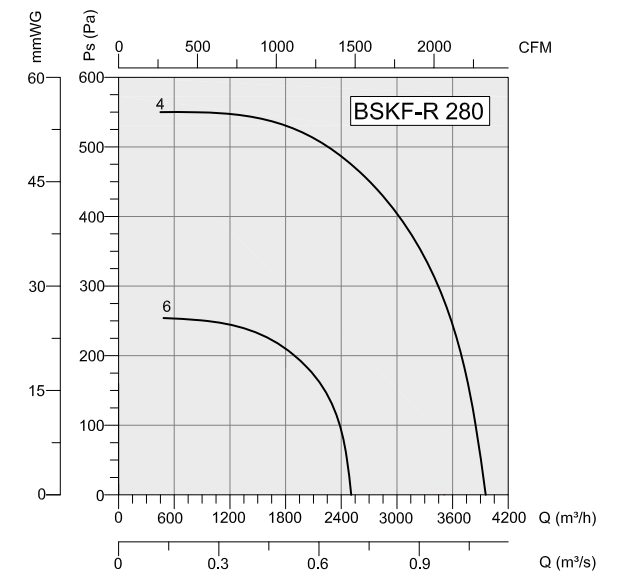
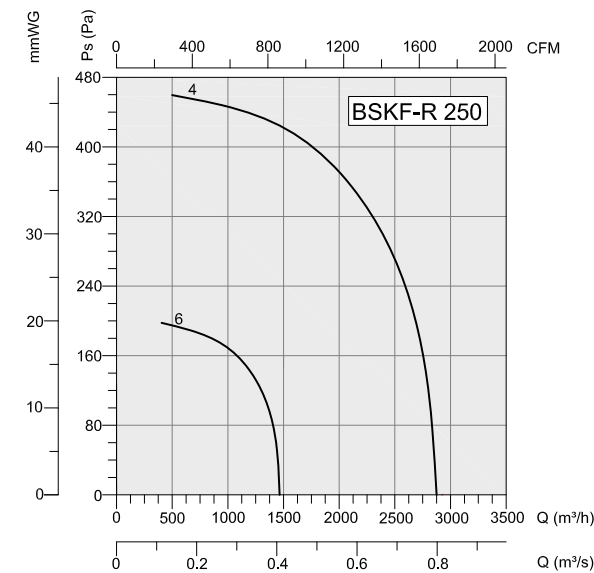
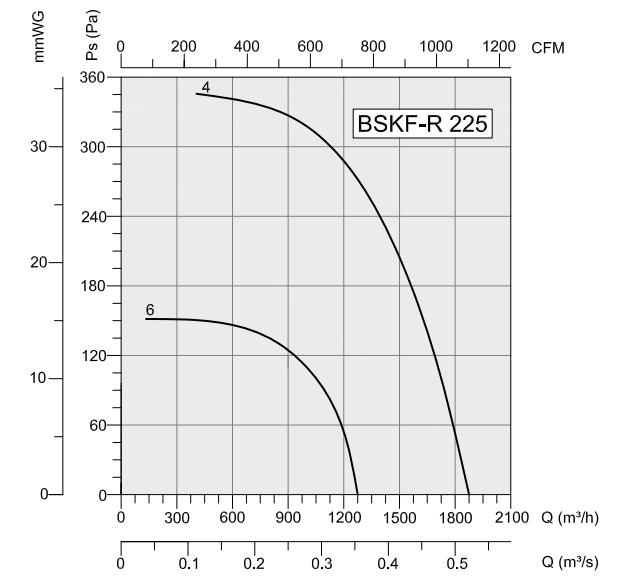
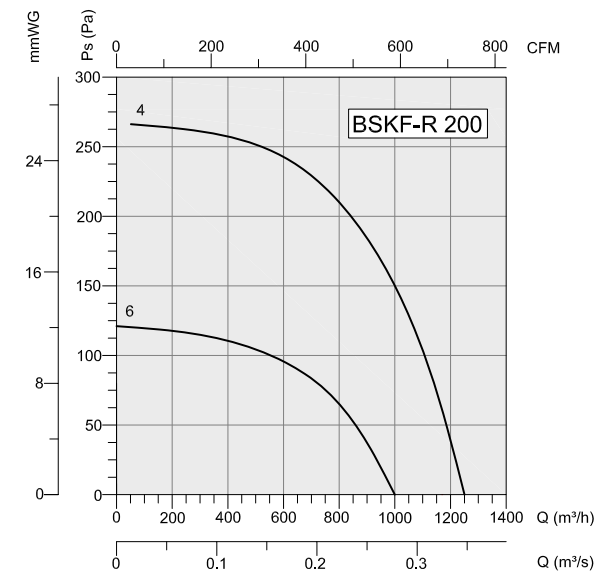

TYPE	VOLTAGE	FREQUENCY	POWER	SPEED	AIR FLOW	WEIGHT
	V	Hz	Kw	rpm	m <sup>3</sup> /h	kg
BSKF-R 200-4	230/380	50	0,25	1400	1250	22
BSKF-R 200-6	230/380	50	0,18	900	1000	21
BSKF-R 225-4	230/380	50	0,37	1400	1875	35
BSKF-R 225-6	230/380	50	0,18	900	1275	33
BSKF-R 250-4	230/380	50	0,55	1400	2850	40
BSKF-R 250-6	230/380	50	0,18	900	1450	37
BSKF-R 280-4	230/380	50	0,75	1400	3950	43
BSKF-R 280-6	230/380	50	0,25	900	2550	39
BSKF-R 315-4	230/380	50	1,5	1400	5000	55
BSKF-R 315-6	230/380	50	0,37	900	4000	52
BSKF-R 355-4	230/380	50	2,2	1400	10125	85
BSKF-R 355-6	230/380	50	1,1	900	6000	81
BSKF-R 400-6	230/380	50	1,5	900	8100	92
BSKF-R 450-4	230/380	50	2,2	900	14000	120

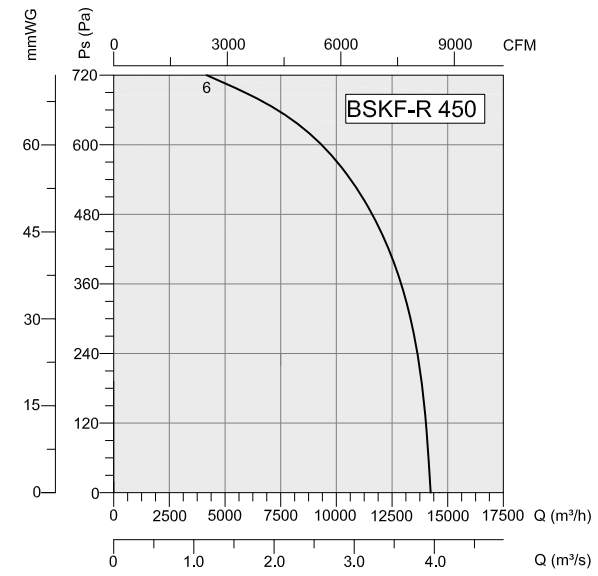
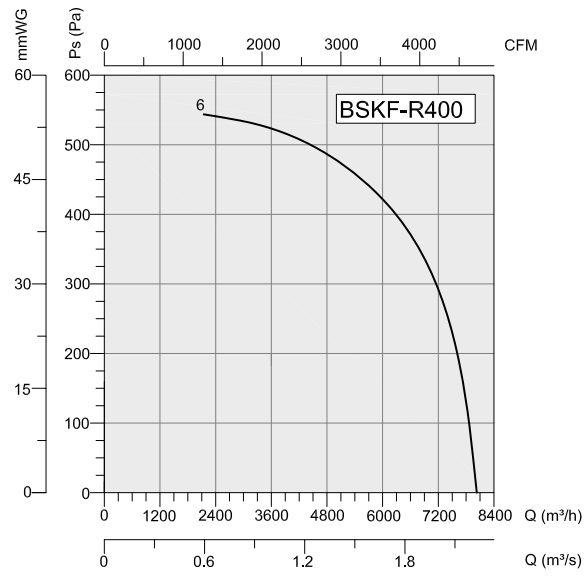
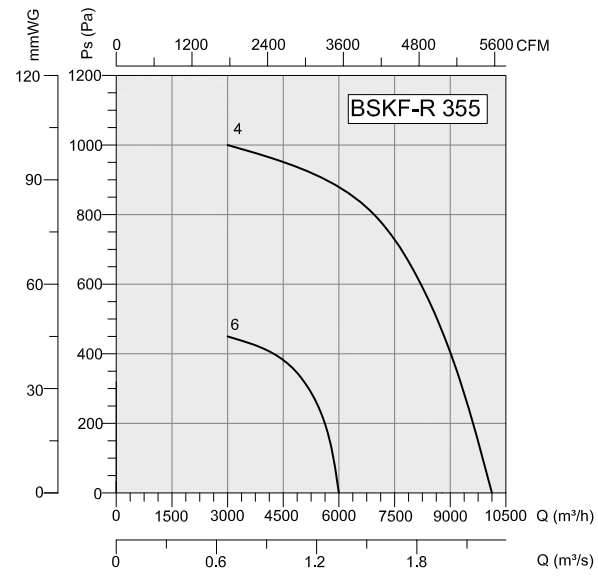
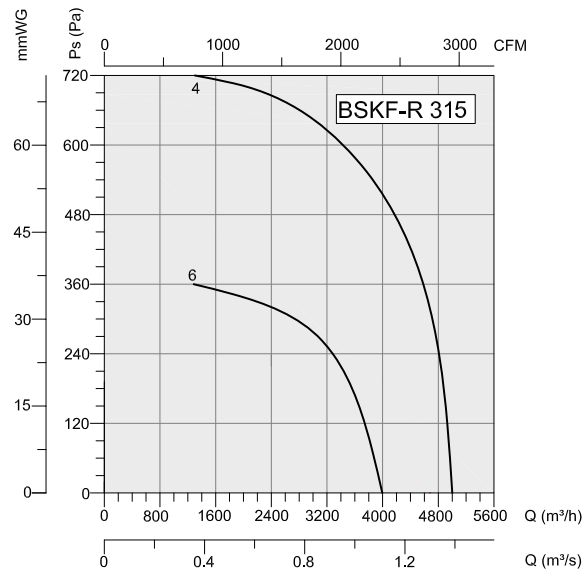

Accessories

