



BACF

AC AXIAL ROOF FANS Horizontal Outlet

It is designed as maintenance-free for a long time. With highly efficient and esthetic structure, it can be mounted at a desired angle. With the ability of both suction and blowing, these fans provide suction and air supply.

Technical Drawing

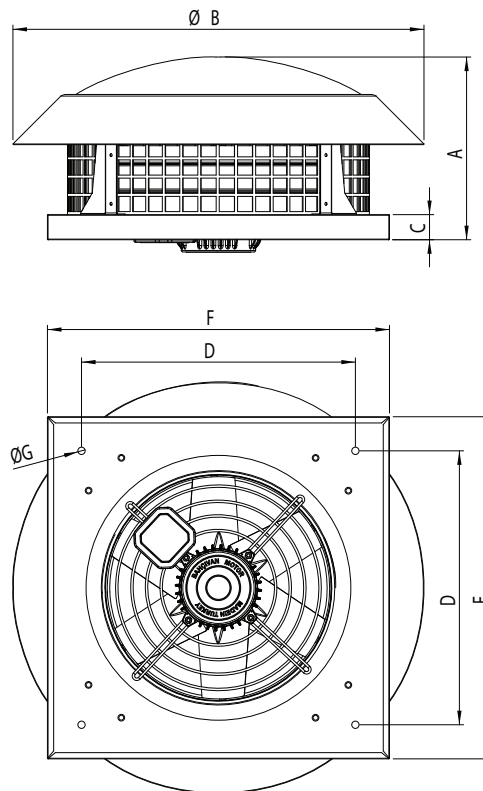

- MATERIAL** : The housing is made of electrostatic powder coated sheet iron; axial impeller is made of glass fiber mixed plastic.
- INSULATION CLASS** : Class F
- DIRECTIVE** : EN 60335-1, EN 60335-2-80
- SPEED CONTROL** : Speed can be adjusted using an optional controller.
- APPLICATION AREAS** : **Residential** ; bathrooms, toilets, utility rooms, indoor swimming pools, gyms, and storerooms. **Commercial** ; cafes, bars, restaurants, shops, schools, offices, factories, buildings, warehouses, night clubs, pubs, hotels, shopping centers, and leisure centers. **Industrial** ; Equipment cooling, workshops, and spot ventilation.

| TYPE | A | B | C | D | F | G |
|-----------|-----|------|----|------|------|----|
| BACF 300 | 320 | 675 | 40 | 450 | 500 | 12 |
| BACF 350 | 320 | 675 | 40 | 450 | 560 | 12 |
| BACF 400 | 470 | 850 | 40 | 530 | 630 | 12 |
| BACF 450 | 480 | 850 | 40 | 590 | 710 | 12 |
| BACF 500 | 480 | 850 | 40 | 680 | 740 | 12 |
| BACF 560 | 710 | 1100 | 40 | 750 | 800 | 14 |
| BACF 630 | 710 | 1250 | 40 | 850 | 850 | 14 |
| BACF 710 | 800 | 1250 | 40 | 850 | 850 | 14 |
| BACF 800 | 900 | 1350 | 40 | 1000 | 1000 | 14 |
| BACF 900 | 900 | 1350 | 40 | 1000 | 1000 | 14 |
| BACF 1000 | 950 | 1450 | 40 | 1050 | 1100 | 14 |

Dimensions are in (mm)

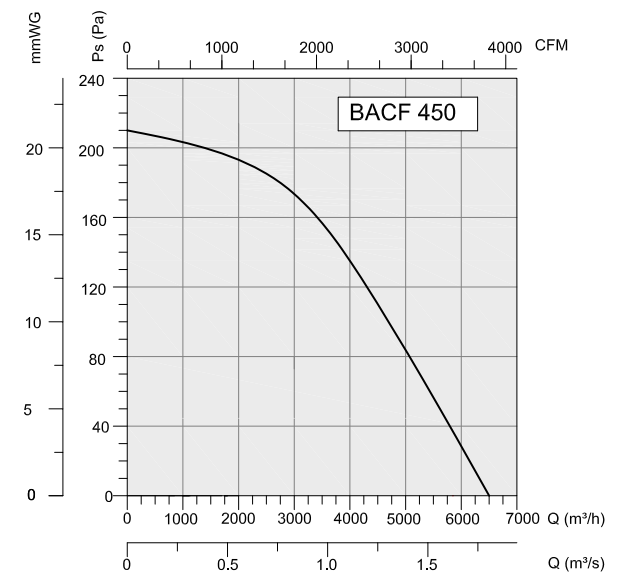
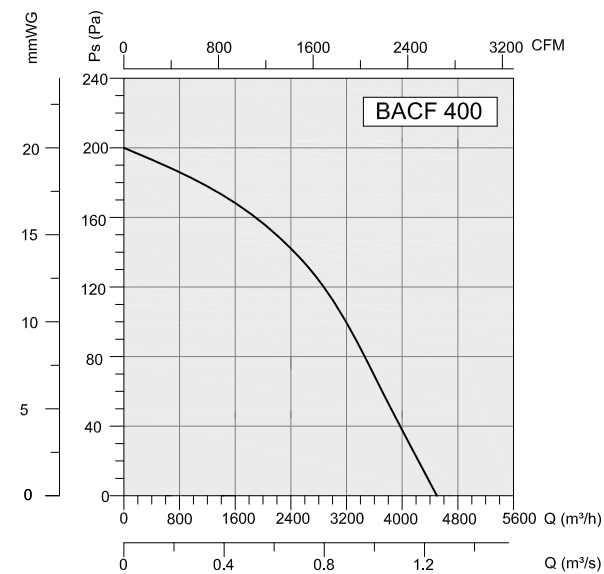
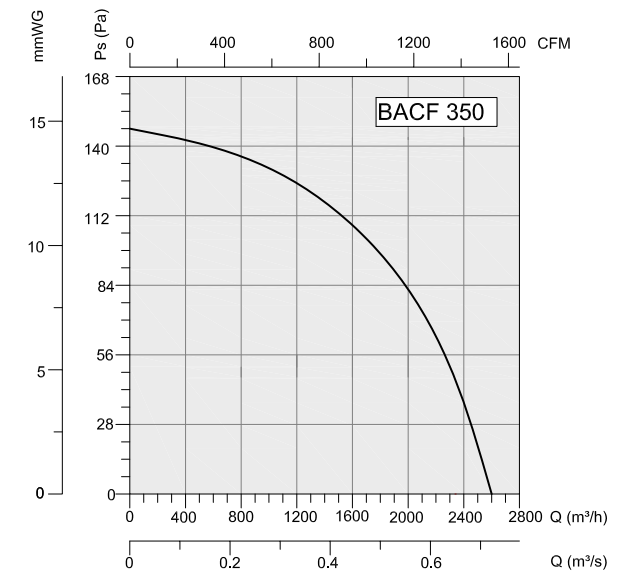
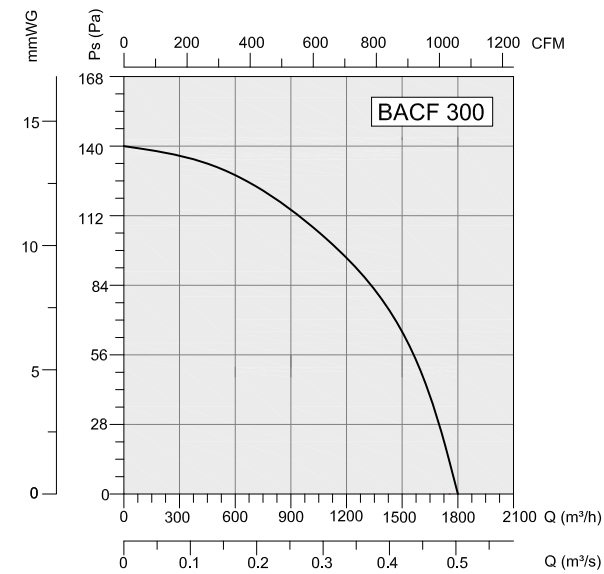

| TYPE | VOLTAGE | FREQUENCY | POWER | CAPACITOR | SPEED | AIR FLOW | SOUND PRESSURE LEVEL | WEIGHT |
|-----------------------|---------|-----------|-------|-----------|-------|----------|----------------------|--------|
| | V | Hz | W | (µF) | rpm | m³/h | dB(A) | kg |
| BACF 300M / BACF 300T | 230/380 | 50 | 180 | 8/- | 1430 | 1800 | 48 | 13.5 |
| BACF 350M / BACF 350T | 230/380 | 50 | 180 | 8/- | 1360 | 2600 | 49 | 17.5 |
| BACF 400M / BACF 400T | 230/380 | 50 | 250 | 8/- | 1400 | 4500 | 51 | 21 |
| BACF 450M / BACF 450T | 230/380 | 50 | 370 | 8/- | 1375 | 6500 | 54 | 30 |
| BACF 500M / BACF 500T | 230/380 | 50 | 550 | 8/- | 1350 | 8500 | 57 | 35 |
| BACF 560M / BACF 560T | 230/380 | 50 | 750 | 20/- | 1450 | 10400 | 62 | 37 |
| BACF 630M / BACF 630T | 230/380 | 50 | 1100 | 30/- | 1450 | 14000 | 63 | 66 |
| BACF 710M / BACF 710T | 230/380 | 50 | 1500 | 40/- | 1450 | 18000 | 68 | 72 |
| BACF 800M / BACF 800T | 230/380 | 50 | 2200 | 50/- | 1450 | 26000 | 72 | 88 |
| BACF 900T | 380 | 50 | 3000 | - | 1450 | 32000 | 77 | 94 |
| BACF 1000T | 380 | 50 | 5500 | - | 1400 | 42000 | 91 | 105 |

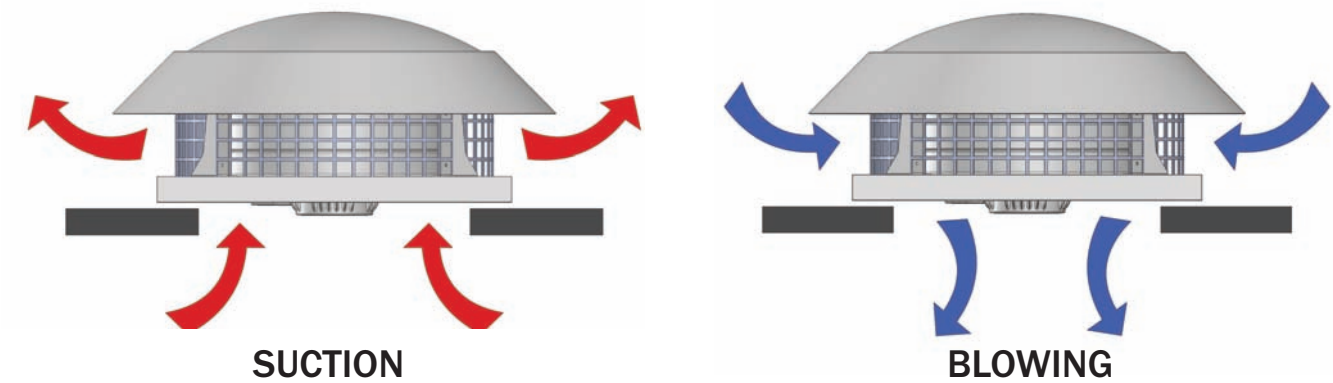
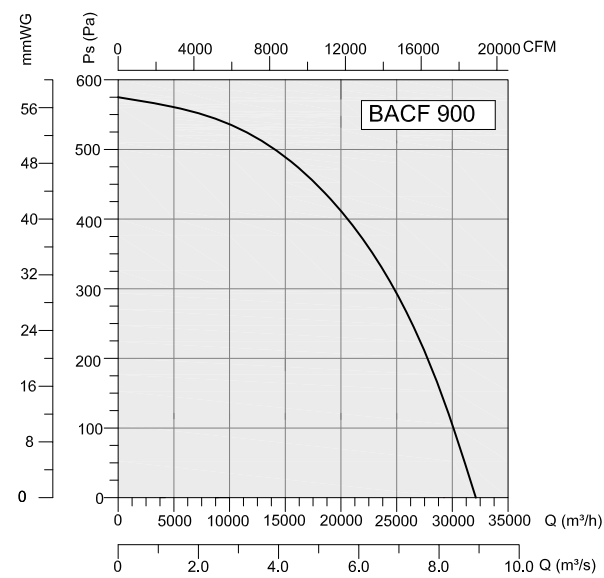
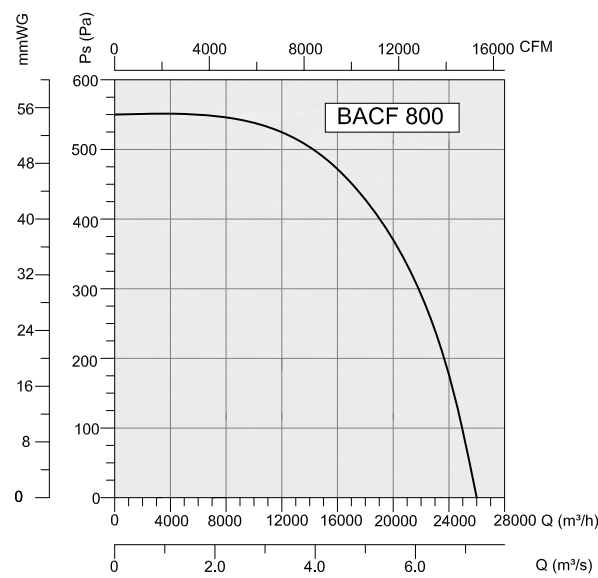
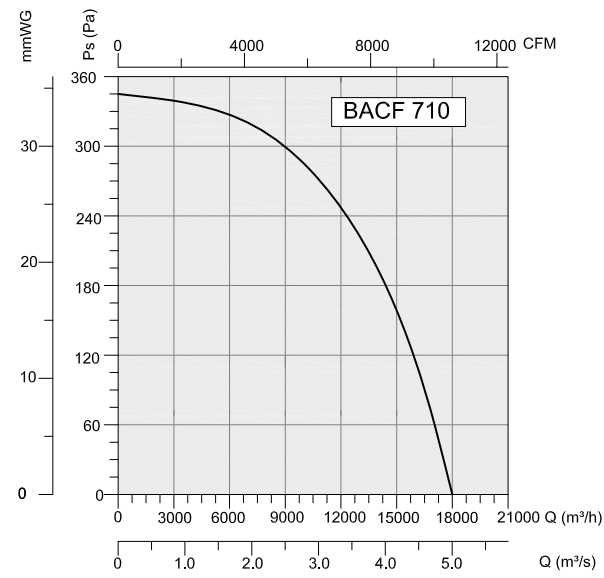
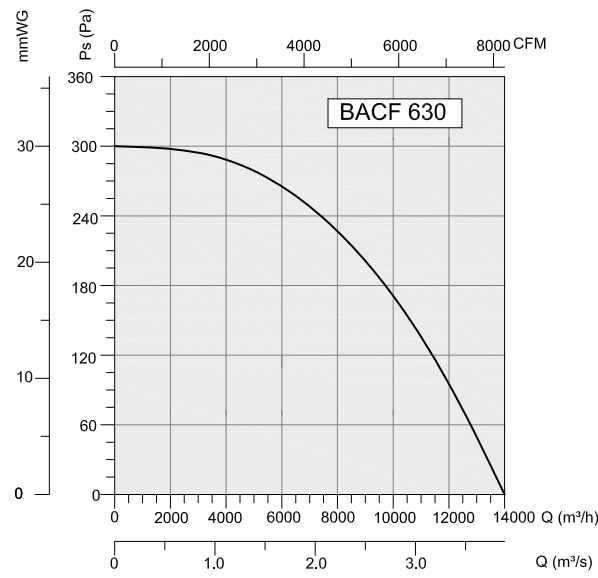
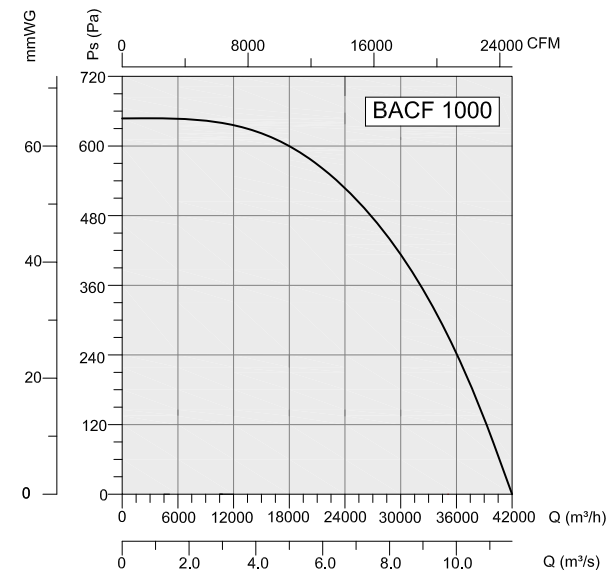
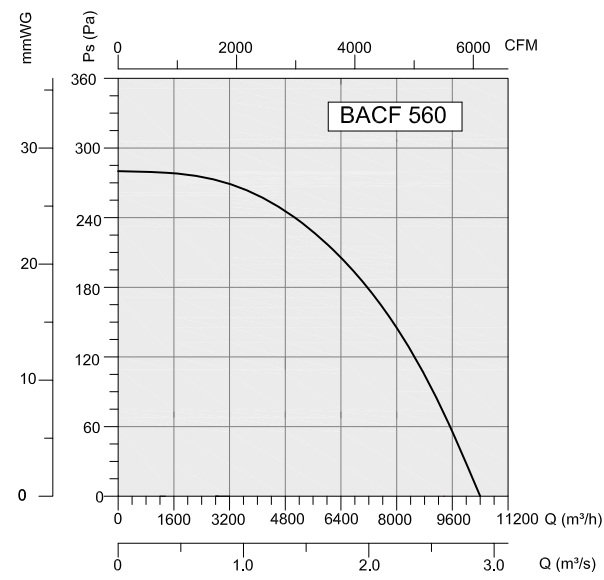
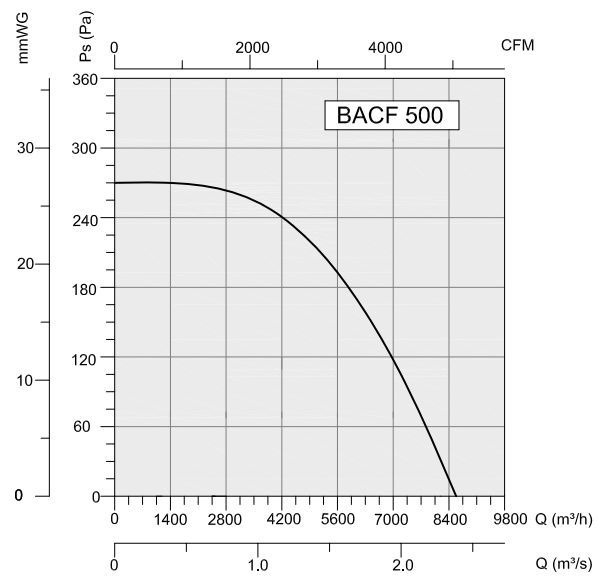

DUCT FANS

ROOF FANS

AXIAL FANS

RADIAL FANS

JET FANS

PLASTIC FANS

VENTILATORS

ACCESSORIES