



# BDS

## AC CENTRIFUGAL BLOWERS Aluminum Housing

Resistant housing structure, high pressure. Single Inlet compact structure benefits space saving for various cooling and ventilation applications.

### Technical Drawing

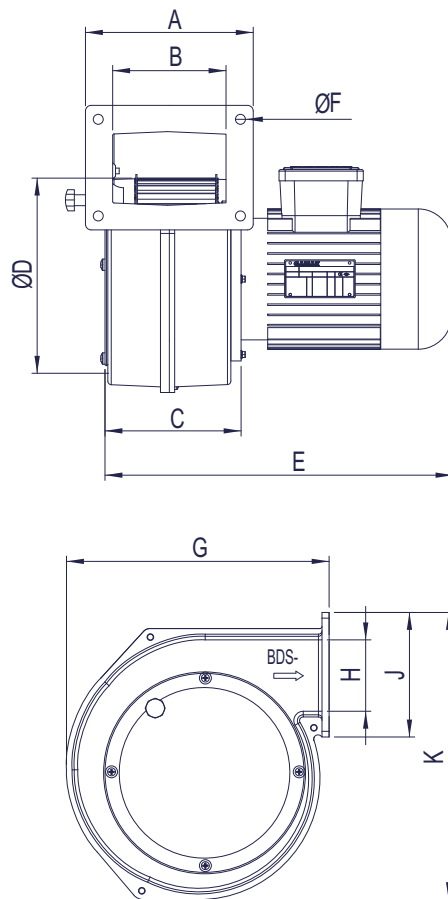

- MATERIAL** : Housing is made of aluminum injection; impeller is forward curved, galvanized.
- INSULATION CLASS** : Class F
- DIRECTIVE** : EN 60335-1, EN 60335-2-80
- SPEED CONTROL** : Speed can be adjusted using an optional controller.
- APPLICATION AREAS** : The BDS centrifugal fan series are perfect for use in industrial and commercial environments, mainly for local cooling applications, blowing in heating systems. Machines cooling, boiler, plastic machines, sock machines, heating with electrical heater applications, jewelry industry etc.

### Accessories



BSC-F

TYPE	A	B	C	D	E	F	G	H	J	K
BDS 1	130	90	110	140	315	10	215	60	110	220
BDS 2	160	115	137	160	324	10	290	105	160	280
BDS 3	160	115	137	180	370	10	303	105	160	290
BDS 4	187	127	148	225	374	10	370	105	160	310
BDS 5	203	158	165	250	435	10	415	105	203	430
BDS 6	203	158	165	268	435	10	415	105	203	450
BDS 7	240	170	230	300	605	10	505	105	240	510
BDS 8	240	170	230	315	605	10	505	105	240	530

Dimensions are in (mm)

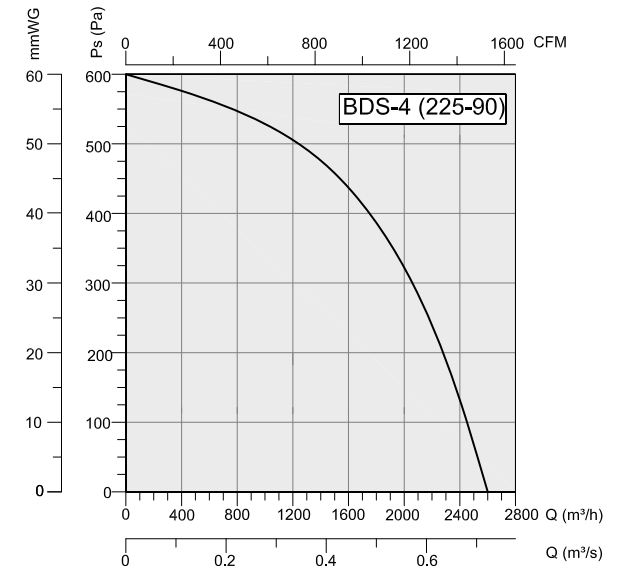
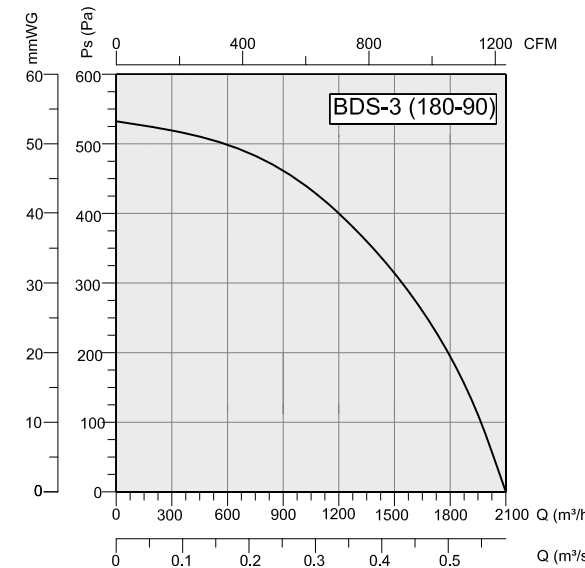
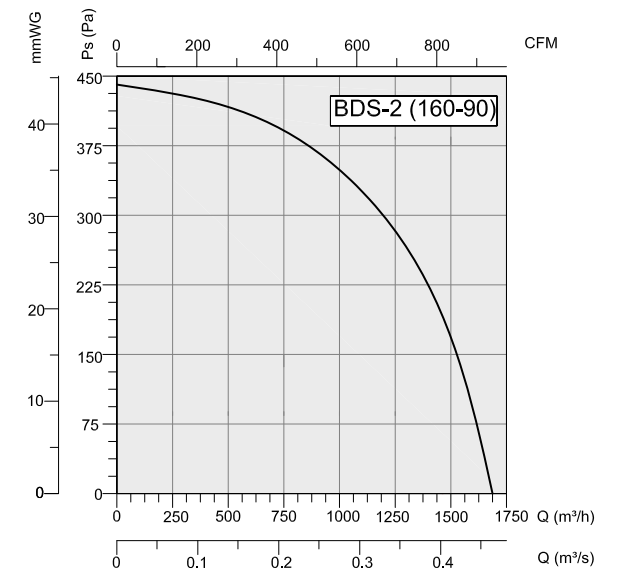
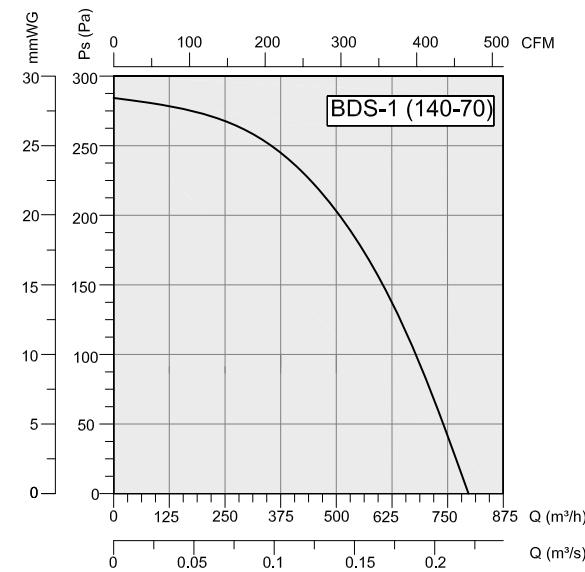

TYPE	VOLTAGE	FREQUENCY	POWER	SPEED	AIR FLOW	SOUND PRESSURE LEVEL	WEIGHT
	V	Hz	W	rpm	m³/h	dB(A)	kg
BDS 1M / BDS 1T (140-70)	230/380	50	250	2450	800	25	9
BDS 2M / BDS 2T (160-90)	230/380	50	370	2800	1700	30	11
BDS 3M / BDS 3T (180-90)	230/380	50	550	2800	2100	34	12
BDS 4M / BDS 4T (225-90)	230/380	50	750	2800	2600	37	18
BDS 4M / BDS 4T (225-102)	230/380	50	1100	2800	3200	40	19
BDS 5M / BDS 5T (250-112)	230/380	50	1500	2800	3700	44	25
BDS 6M / BDS 6T (268-112)	230/380	50	2200	2800	4650	55	31
BDS 7T (300-112)	380	50	4000	2800	6200	60	43
BDS 8T (315-112)	380	50	5500	2800	8400	69	48

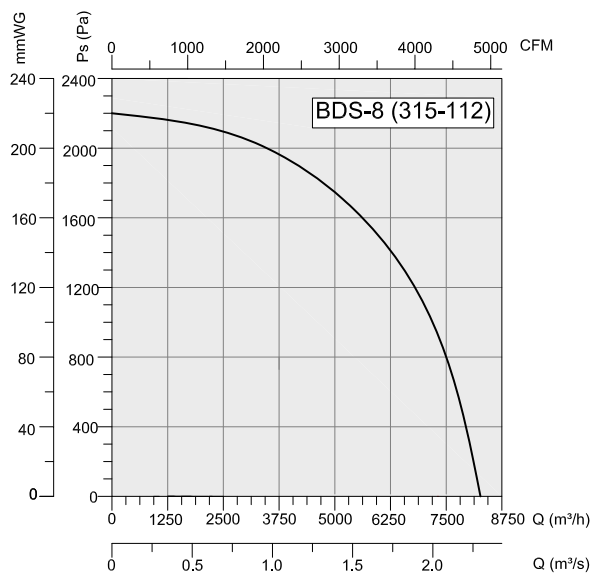
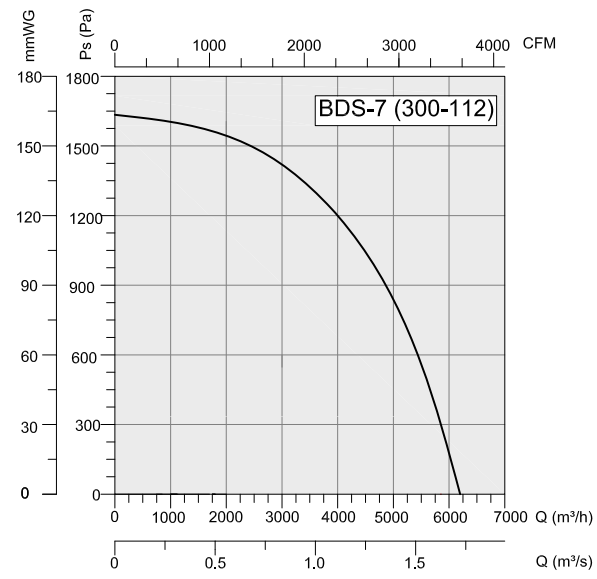
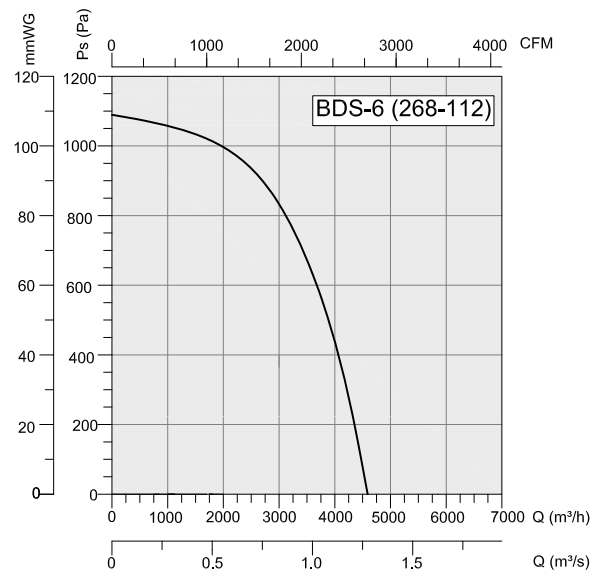
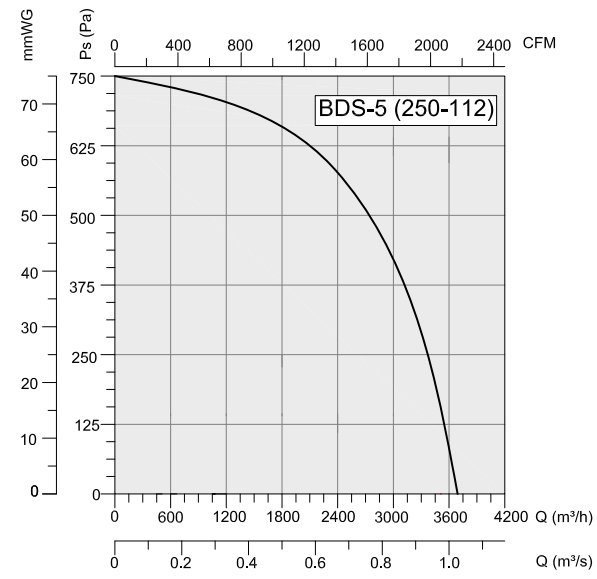
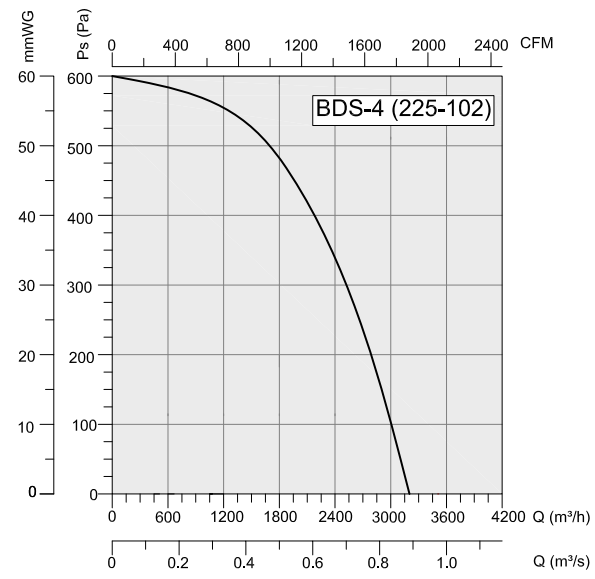

DUCT FANS

ROOF FANS

AXIAL FANS

**RADIAL FANS**

JET FANS

PLASTIC FANS

VENTILATORS

ACCESSORIES