



BGSS

AC LOW PRESSURE CENTRIFUGAL FANS
Backward Curved, Large Blade

BGSS supply highest air flow at low statik pressure.
Flowrate: 3500 – 40000 m³/h
Pressure: 40 – 280 mmWC
Direct coupled to motor (single phase-three phase)

Technical Drawing

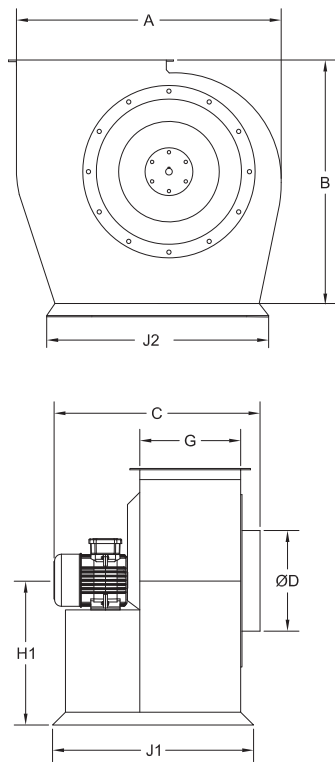

- MATERIAL** : Housing is made electrostatic powder coated sheet metal, backward curved fan is made of sheet metal.
- INSULATION CLASS** : Class F
- DIRECTIVE** : EN 60335-1, EN 60335-2-80
- SPEED CONTROL** : Speed can be adjusted using an optional controller.
- APPLICATION AREAS** : For clean air suction, industrial areas, residential and industrial air conditioning systems, shelter, mine, tunnel ventilation, junk depots and barns, to cool plastic, cloth and glass boards, to dry fodder, paper, grain, varnish, woodens and to separate bad smell gases and toxic gases etc.

TYPE	A	B	C	ØD	G	H1	J1	J2	OUTLET DIMENSIONS	
									a	b
BGSS 1	648	602	524	350	240	355	490	480	352	246
BGSS 2	750	671	570	400	260	400	530	520	402	266
BGSS 3	880	782	660	450	320	462	615	600	452	326
BGSS 4	880	782	685	480	340	462	635	600	452	346
BGSS 5	960	862	750	500	350	515	690	640	502	356
BGSS 6	1051	939	780	560	370	555	710	680	563	378
BGSS 7	1051	939	865	600	390	555	760	730	563	398
BGSS 8	1160	1060	915	630	410	680	820	810	633	418
BGSS 9	1160	1060	975	680	430	680	880	860	633	438
BGSS 10	1322	1205	1090	710	460	730	1070	970	713	468
BGSS 11	1322	1205	1160	760	490	730	1160	970	713	498
BGSS 12	1491	1295	1230	800	520	825	1180	1030	803	528
BGSS 13	1491	1295	1290	830	540	825	1250	1030	803	548

Dimensions are in (mm)

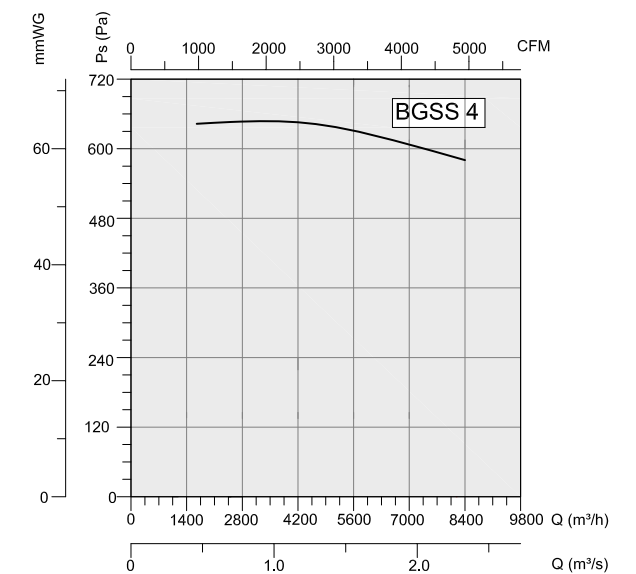
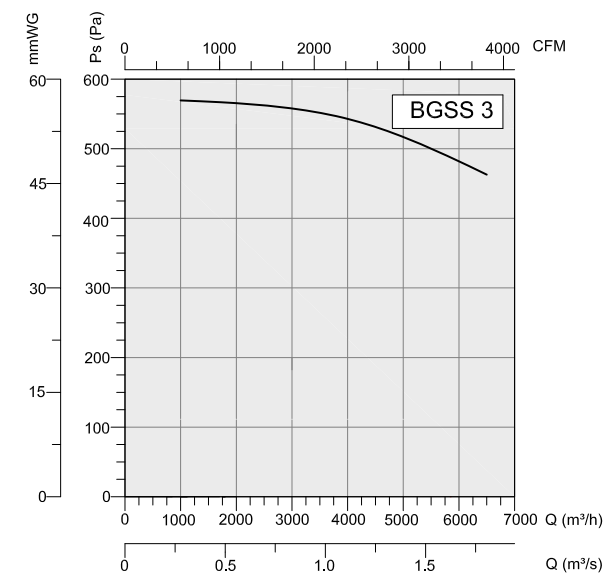
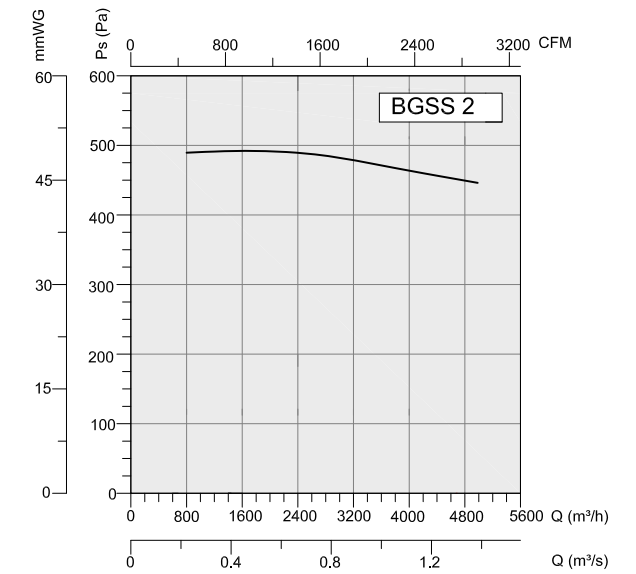
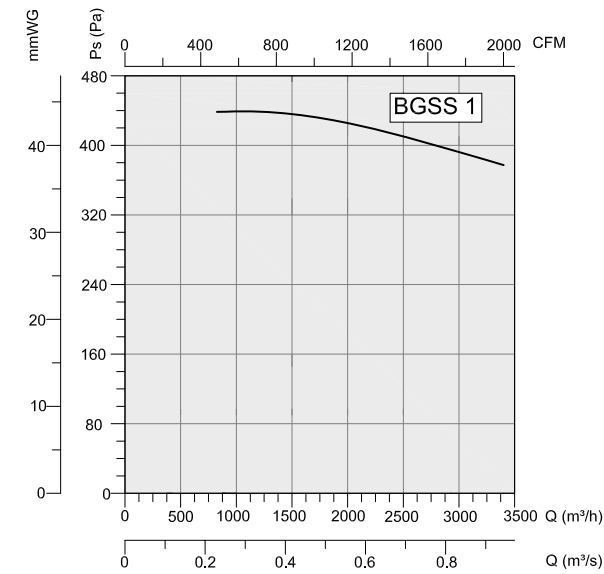

TYPE	VOLTAGE	FREQUENCY	POWER	SPEED	AIR FLOW	PRESSURE
	V	Hz	Kw	rpm	m ³ /h	Pa
BGSS 1	230/380	50	0.37	1400	3500	400
BGSS 2	230/380	50	0.75	1400	5000	500
BGSS 3	230/380	50	1.1	1400	6500	600
BGSS 4	230/380	50	1.5	1400	8000	700
BGSS 5	230/380	50	2.2	1400	9000	750
BGSS 6	230/380	50	3	1400	13000	1000
BGSS 7	380	50	4	1400	15000	1100
BGSS 8	380	50	5.5	1400	18000	1250
BGSS 9	380	50	7.5	1400	21000	1500
BGSS 10	380	50	11	1400	25000	1700
BGSS 11	380	50	15	1400	28000	1900
BGSS 12	380	50	18.5	1400	32000	2000
BGSS 13	380	50	22	1400	40000	2200

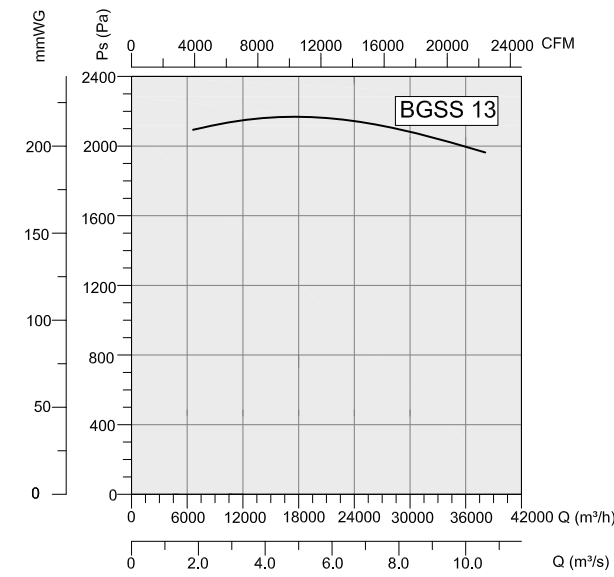
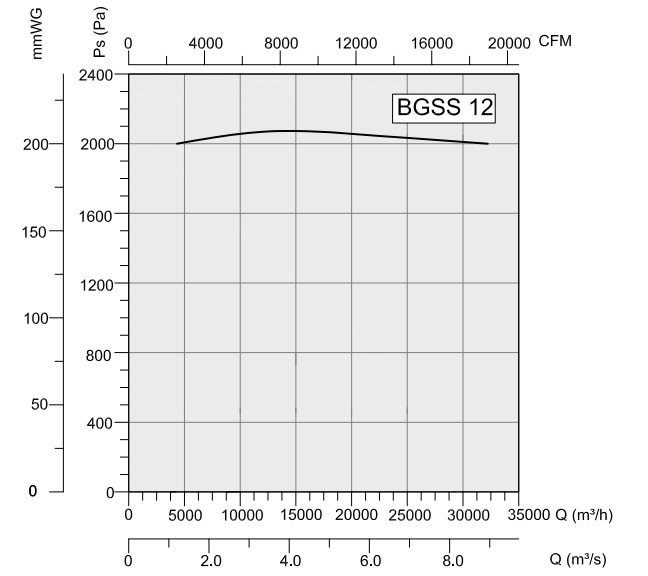
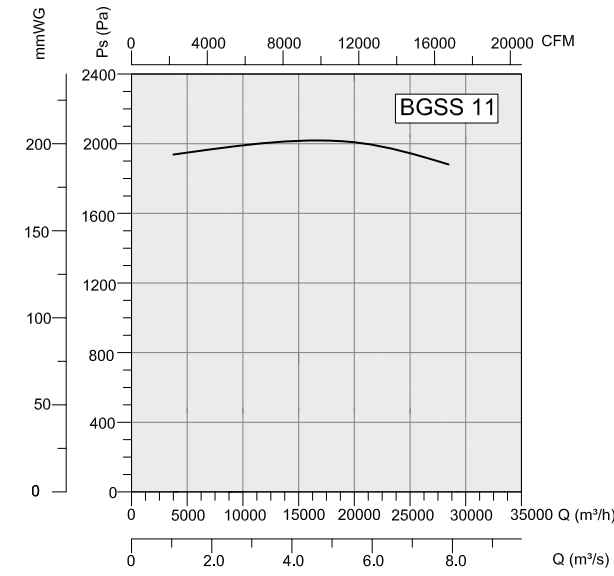
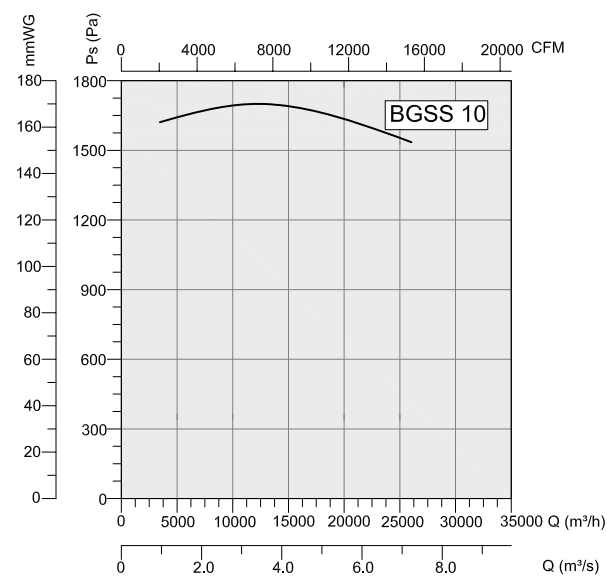
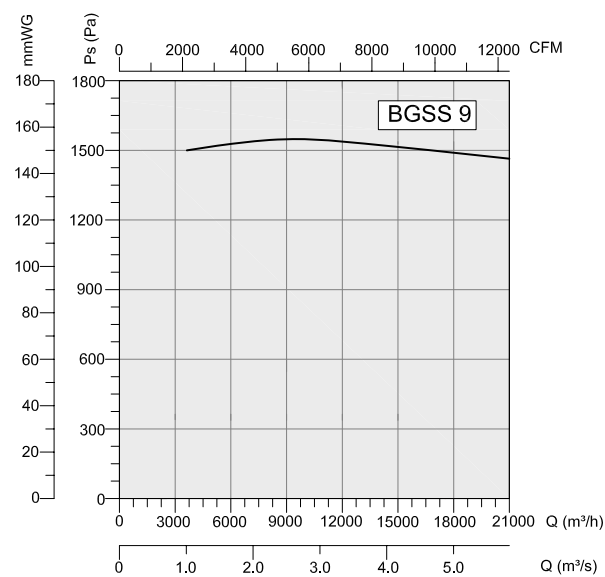
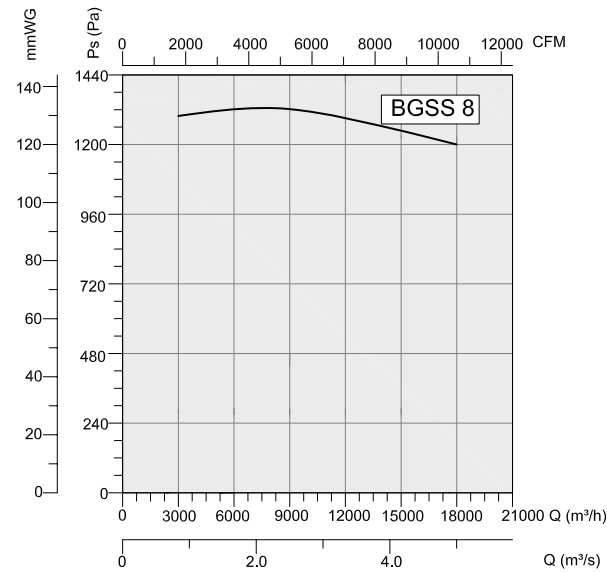
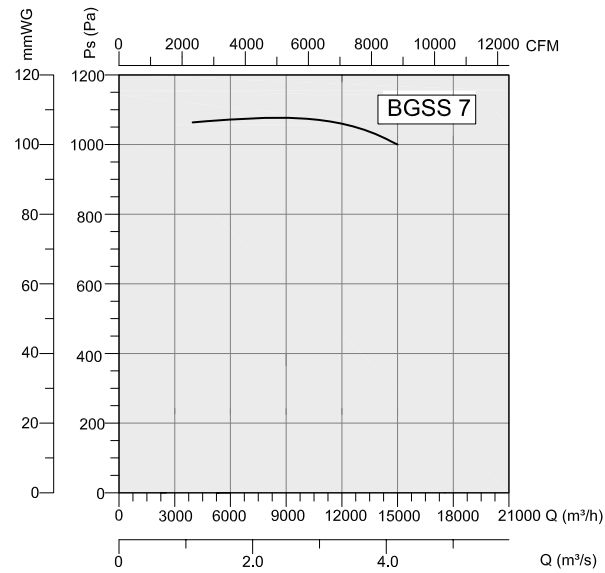
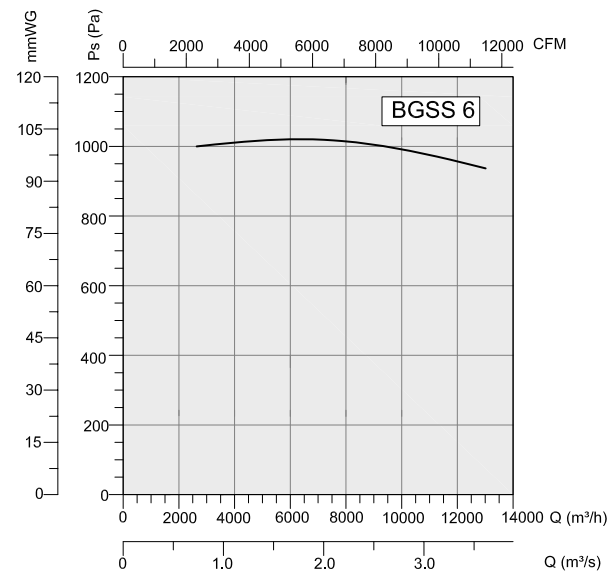
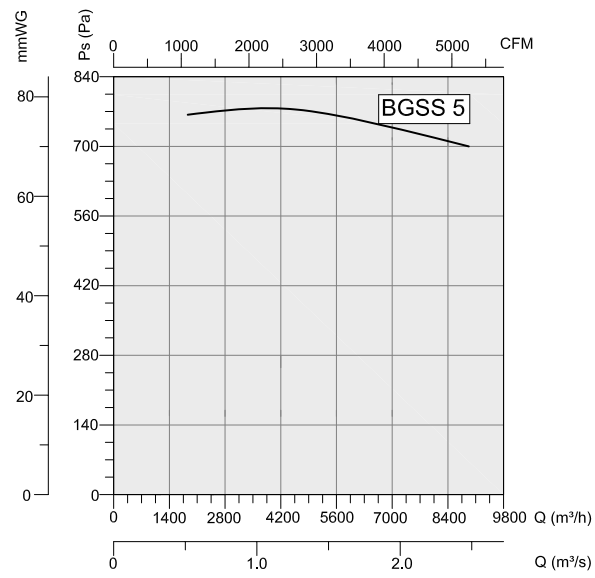

SUCTION - BLOWING DIRECTIONS

