



# BRF-V

## AC CENTRIFUGAL ROOF FANS Vertical Outlet

Roof Mounted Fans are perfect solution for ventilation needs where "polluted air exhaust" is at a premium. BRF-V roof fans are perfect for the places where air can not be ventilated horizontally. Rain drops are vented out by venting holes to prevent them get inside the chimney.

### Technical Drawing

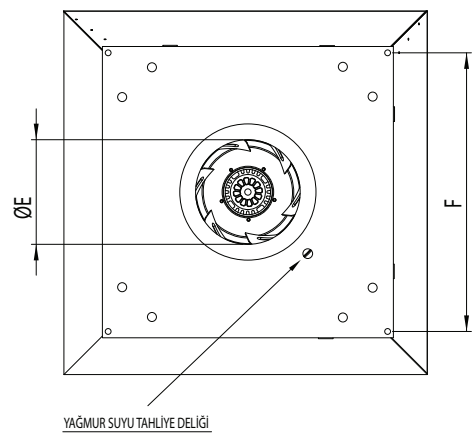

- MATERIAL** : The housing is made of galvanized sheet, backward curved impeller is made of also galvanized sheet metal.
- INSULATION CLASS** : Class B or Class F
- DIRECTIVE** : EN 60335-1, EN 60335-2-80
- SPEED CONTROL** : Speed can be adjusted using an optional controller.
- APPLICATION AREAS** : For industrial and constructional applications, in factories, hospitals, night clubs, offices, kitchens, bathrooms, theaters, condominiums, restaurants, etc.

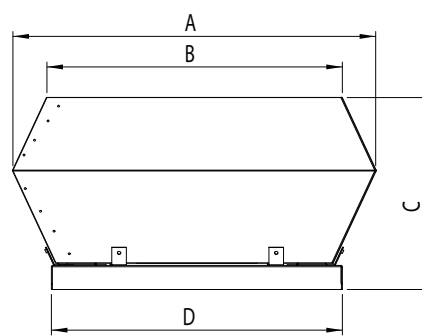

| TYPE      | A    | B   | C   | D   | E   | F   |
|-----------|------|-----|-----|-----|-----|-----|
| BRF-V 225 | 370  | 295 | 170 | 335 | 213 | 245 |
| BRF-V 315 | 560  | 470 | 330 | 435 | 285 | 330 |
| BRF-V 355 | 720  | 618 | 400 | 595 | 438 | 450 |
| BRF-V 400 | 720  | 618 | 400 | 595 | 438 | 450 |
| BRF-V 450 | 900  | 748 | 440 | 665 | 438 | 535 |
| BRF-V 500 | 900  | 748 | 440 | 665 | 438 | 535 |
| BRF-V 560 | 1150 | 955 | 530 | 939 | 605 | 750 |

Dimensions are in (mm)

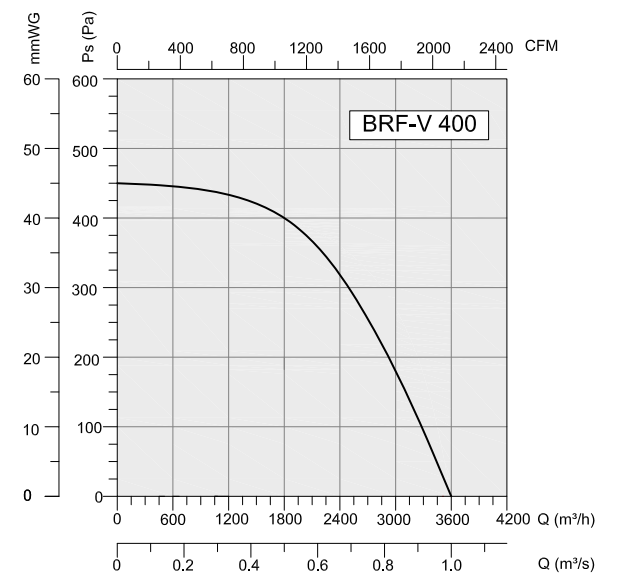
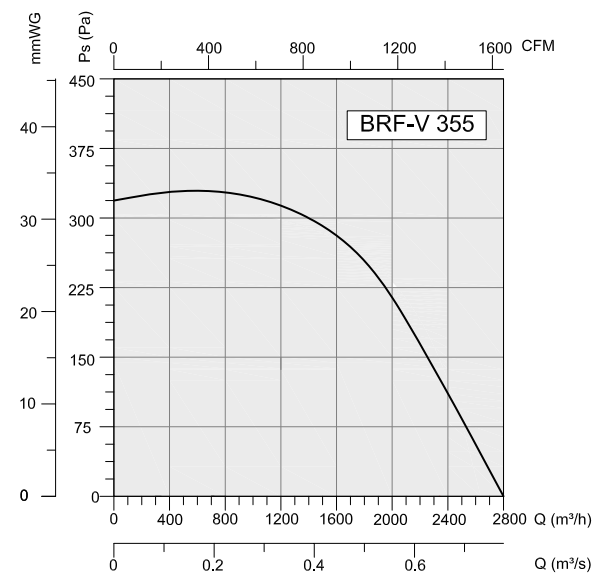
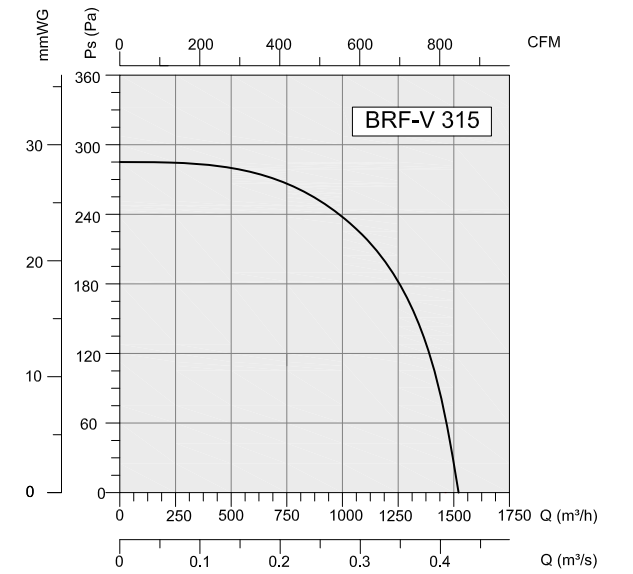
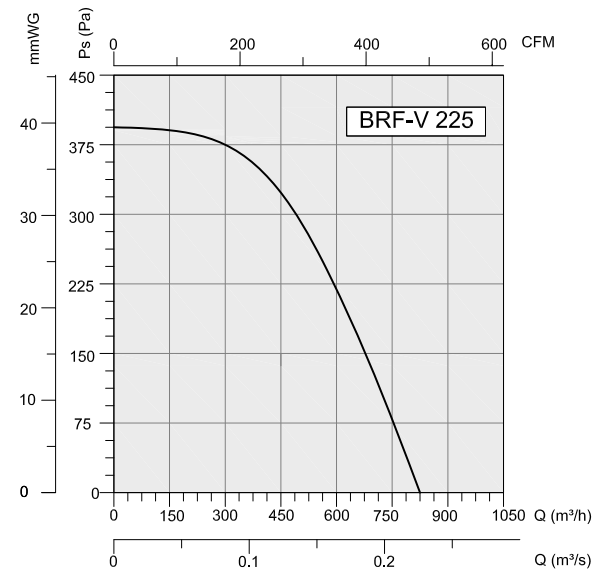

| TYPE      | VOLTAGE | FREQUENCY | POWER | CAPACITOR | SPEED | AIR FLOW          | SOUND PRESSURE LEVEL | WEIGHT |
|-----------|---------|-----------|-------|-----------|-------|-------------------|----------------------|--------|
|           | V       | Hz        | W     | (μF)      | rpm   | m <sup>3</sup> /h | dB(A)                | kg     |
| BRF-V 225 | 230     | 50        | 130   | 5         | 2640  | 850               | 48                   | 7      |
| BRF-V 315 | 230     | 50        | 120   | 4         | 1420  | 1550              | 54                   | 10     |
| BRF-V 355 | 230     | 50        | 200   | 6         | 1400  | 2800              | 58                   | 16     |
| BRF-V 400 | 230     | 50        | 345   | 12        | 1375  | 3600              | 62                   | 29     |
| BRF-V 450 | 230     | 50        | 595   | 18        | 1365  | 5800              | 63                   | 37     |
| BRF-V 500 | 380     | 50        | 880   |           | 1400  | 8000              | 65                   | 51     |
| BRF-V 560 | 380     | 50        | 1450  |           | 1400  | 10000             | 66                   | 62     |

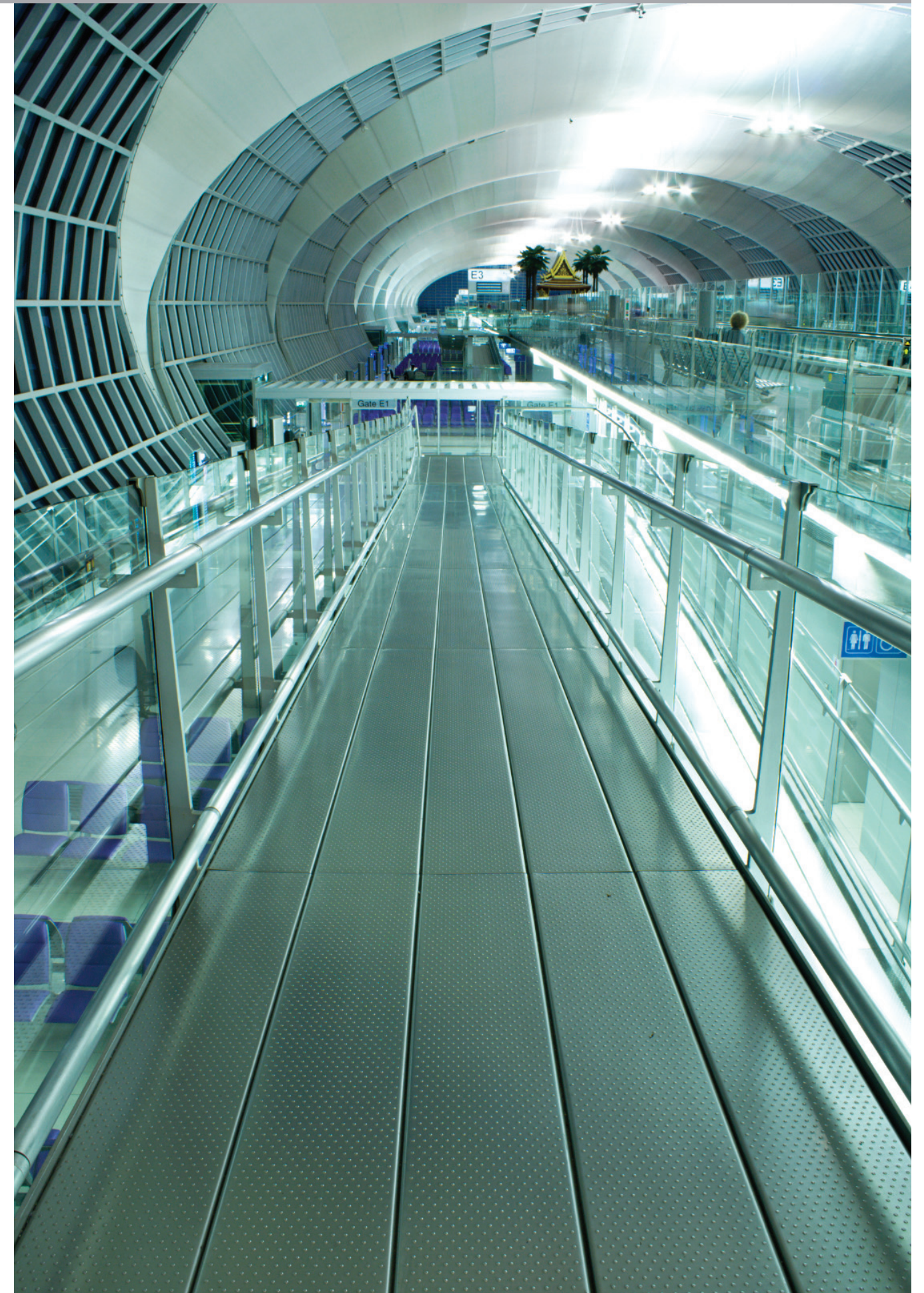
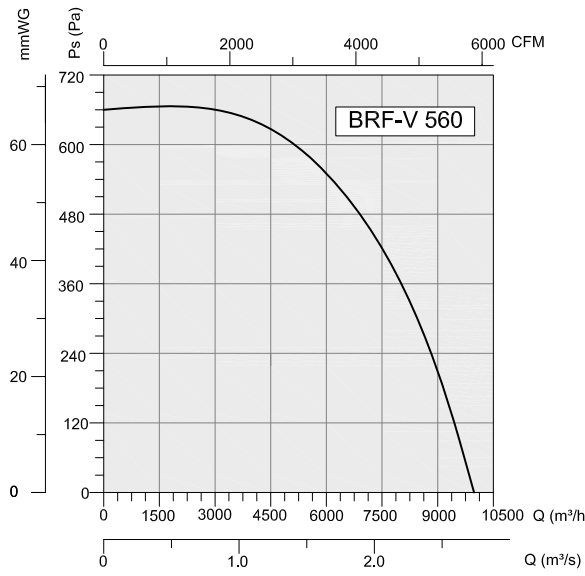
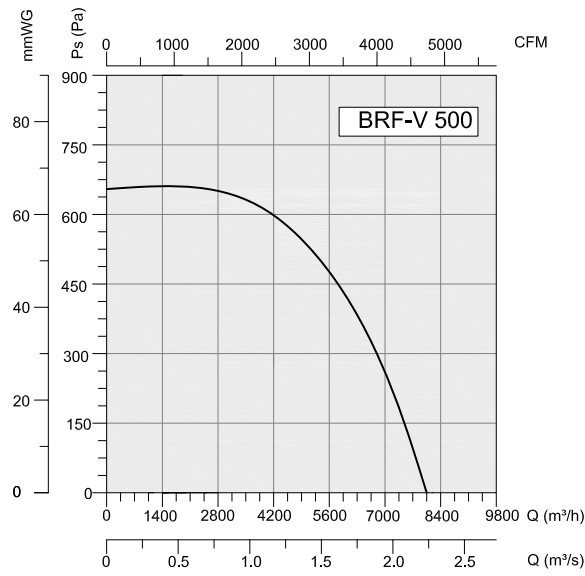
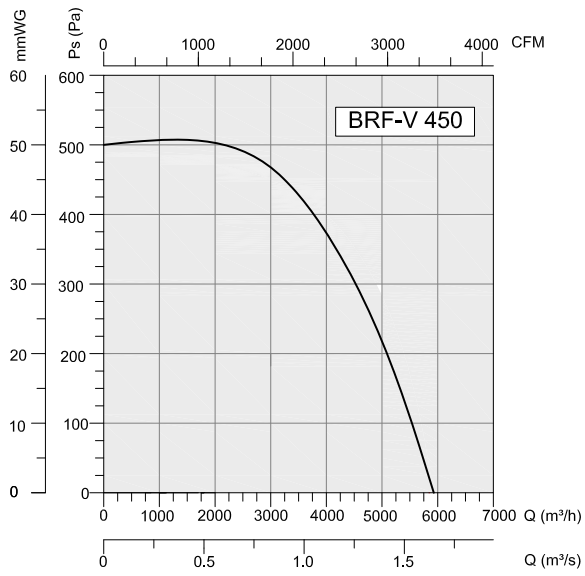

DUCT FANS

ROOF FANS

AXIAL FANS

RADIAL FANS

JET FANS

PLASTIC FANS

VENTILATORS

ACCESSORIES